



	Seat - Assise	Backrests - Dossiers	Structure - Structure	
Upholstering Revetement (8)	Removable <i>Déhoussable</i>			
	Not removable <i>Non déhoussable</i>	-	-	
Padding Rembourrages (4-5-6-7)	+ D.35kg/m³	+ D.21kg/m³	+ Polyurethane foam	 ETHICALLY SOFT MADE optional

TECHNICAL INFORMATION

Structure: 1

Structure in solid wood panels, plywood, laminated solid FIR bearing various thicknesses supported by shaped steel frame.

Springing: 1-2

The back is made of multilayered wood or class E1 wood particleboard panels. The seat is supported by propylene and latex elastic belts.

Note:

For optional Bjorg feet available in the finishes (ME04) shiny chrome or (ME05) black chrome apply the surcharge that it's indicated in the section "available feet".

Epoque optional metal base available in the finish black chrome (ME05) and eucalyptus wooden support (LE05).

INFORMATIONS TECHNIQUES

Structure: 1

Structure porteuse en panneau de bois contreplaqué latté et partie massives en sapin de différentes épaisseur, supporté par un encadrement en acier façonné.

Suspension: 1-2

Dossier en panneaux de bois multiplis ou particules de bois en classe E1. Assise avec sangles élastiques de fibre propylénique et latex.

Note:

Pour les pieds en option Bjorg disponibles dans les finitions (ME04) chrome brillant ou (ME05) chrome noir appliquer la majoration qui est indiqué sur la section "Pieds disponibles".

Piètement en option Epoque en métal finition noir chromé disponible dans la finition noir chromé (ME05) et support en bois finition eucalyptus (LE05).

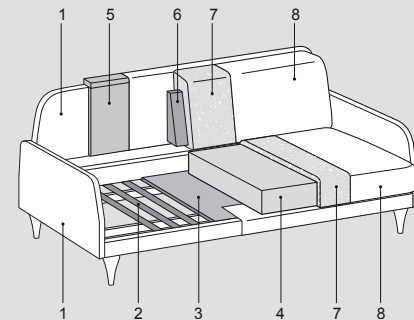
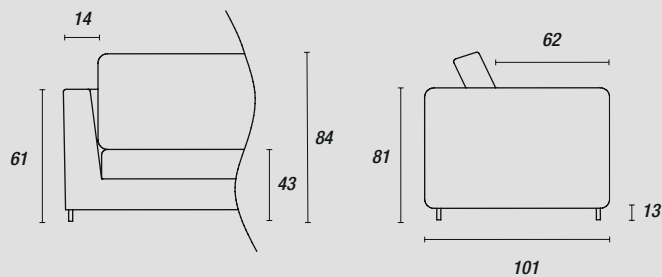

Feet - Pieds::









standard H.13cm Eucalyptus (LE05)	optional Epoque H.13cm at a surcharge Black Chrome (ME05) Eucalyptus (LE05)	optional Bamboo H.13cm at a surcharge Black (ME09)	optional Bjorg H.13cm Black (ME09) Light brown (ME11) Anthracite (ME01) Dark brown (ME03)	optional Bjorg H.13cm at a surcharge Shining Chromium (ME04) Black Chrome (ME05)
--	--	--	---	---

Accessories - Accessoires:

Top Anthracite (ME01) Dark brown (ME03)
--

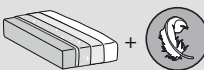
Elliot mix



	Seat - Assise	Backrests - Dossiers	Structure - Structure	
Upholstering Revetement (8)	Removable <i>Déhoussable</i>			-
	Not removable <i>Non déhoussable</i>	-	-	 &  Cat. Soft
Padding Rembourrages (4-5-6-7)	 D.35kg/m³	 D.21kg/m³	 Polyurethane foam	 optional

TECHNICAL INFORMATION

Structure: 1

Structure in solid wood panels, plywood, laminated solid FIR bearing various thicknesses supported by shaped steel frame.

Springing: 1-2

The back is made of multilayered wood or class E1 wood particleboard panels. The seat is supported by propylene and latex elastic belts.

Note:

External part of the structure covered in Sidney leather, internal part in fabric, for articles upholstered with leather parts from other categories, consider the indicated surcharge; for sofas with body completely covered in leather please apply 10% surcharge. For optional Bjorg feet available in the finishes (ME04) shiny chrome or (ME05) black chrome apply the surcharge that it's indicated in the section "available feet".

Epoque optional metal base available in the finish black chrome (ME05) and eucalyptus wooden support (LE05).

INFORMATIONS TECHNIQUES

Structure: 1

Structure porteuse en panneau de bois contreplaqué latté et partie massives en sapin de différentes épaisseur, supporté par un encadrement en acier façonné.

Suspension: 1-2

Dossier en panneaux de bois multiplis ou particules de bois en classe E1. Assise avec sangles élastiques de fibre propylénique et latex.



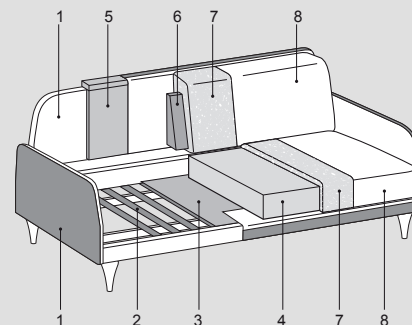
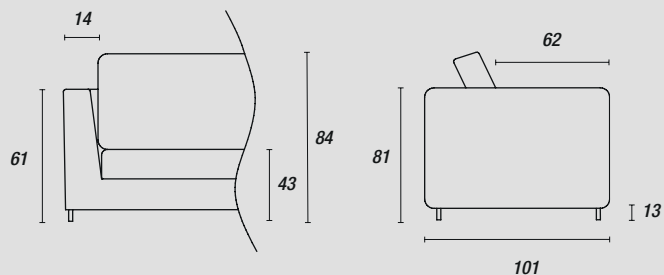

Note:

Partie extérieure de la structure revetue en cuir Sidney, partie interne en tissu, pour articles revetus avec des parties en cuir d'autre catégories, rajouter la majoration qui est indiquée; pour structure complètement revetue en cuir considerer une majoration du 10%. Pour les pieds en option Bjorg disponibles dans les finitions (ME04) chrome brillant ou (ME05) chrome noir appliquer la majoration qui est indiqué sur la section "Pieds disponibles".

Piètement en option Epoque en métal finition noir chromé disponible dans la finition noir chromé (ME05) et support en bois finition eucalyptus (LE05).



Feet - Pieds::

standard  H.13cm Eucalyptus (LE05)	optional Epoque  H.13cm at a surcharge Black Chrome (ME05) Eucalyptus (LE05)	optional Bamboo  H.13cm at a surcharge Black (ME09)	optional Bjorg  H.13cm Black (ME09) Light brown (ME11) Anthracite (ME01) Dark brown (ME03)	optional Bjorg  H.13cm at a surcharge Shining Chromium (ME04) Black Chrome (ME05)
---	---	---	--	--

Accessories - Accessoires:

Top  Anthracite (ME01) Dark brown (ME03)
