

# Clip



	Seat - Assise	Backrests - Dossiers	-	Footstool - Pouf
<b>Upholstering Revetement (6)</b>	Removable Déhoussable —	Removable Déhoussable —	-	Fabric
	Not removable Non déhoussable Fabric	Not removable Non déhoussable Fabric		Fabric
<b>Padding Rembourrages (3-4-5)</b>	D.30kg/m³ Tecnoform	Sheet D.25kg/m³ Tecnoform		

## TECHNICAL INFORMATION

### Structure: 1

Supporting structure of plywood and pinewood with parts of E1 class agglomeration panels or cellulose agglomeration panels.

### Springing: 2

The back is made of hard or cellulose wooden fibre panels.  
Seat with pre-tensioned crossed propylene fibre and latex elastic webbing.

### Note:

Optional wooden base for sofas and armchair. Metal rotating base for swivel armchair.  
Bench with laquered metal top and feet, laquered metal small tables.

## INFORMATIONS TECHNIQUES

### Structure: 1

Structure porteuse en panneaux de bois multiplis et partie en sapin massif de différentes épaisseurs, panneaux de tamponnement de particules de bois en classe E1.

### Suspension: 2

Dossier en panneaux de fibre de bois dure ou cellulose.  
Assise en rubans élastique de fibre propylène et latex croisés et mécaniquement pré-tensionnés.

### Note:

Canapés et fauteuil avec piètement en bois en option. Piètement pivotant du fauteuil swivel en métal. Banquette avec plan et pieds en métal verni, tables en métal verni.

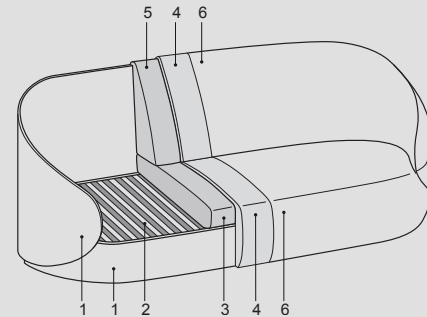
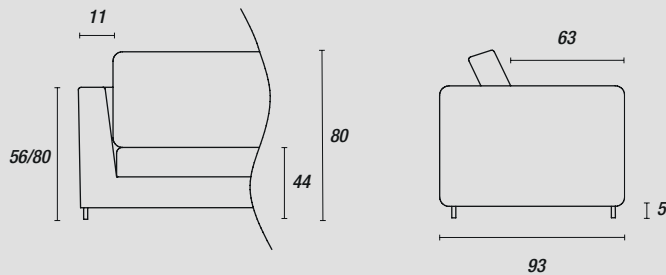

### Feet - Pieds::

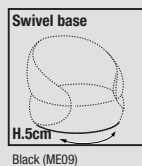
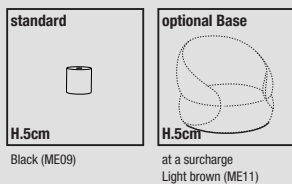

### Accessories - Accessoires:

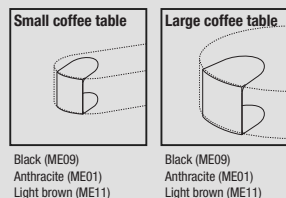

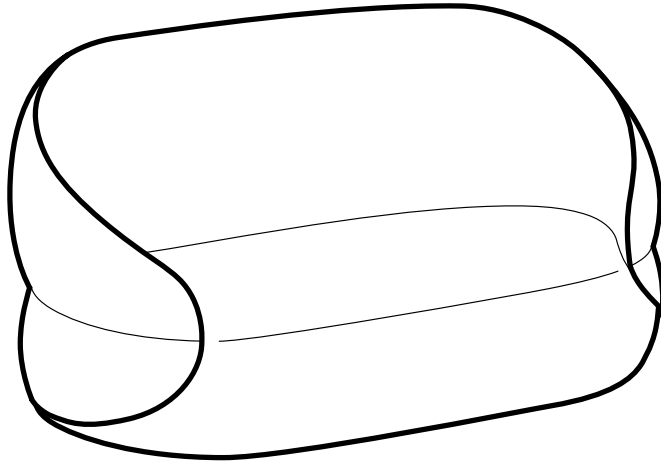

### 2-er sofa

- **Height:** 80cm
- **Width:** 161cm
- **Weight:** 53kg
- **Depth:** 93cm
- **Fabric:** 8,2mt
- **Volume:** 1,43 m<sup>3</sup>

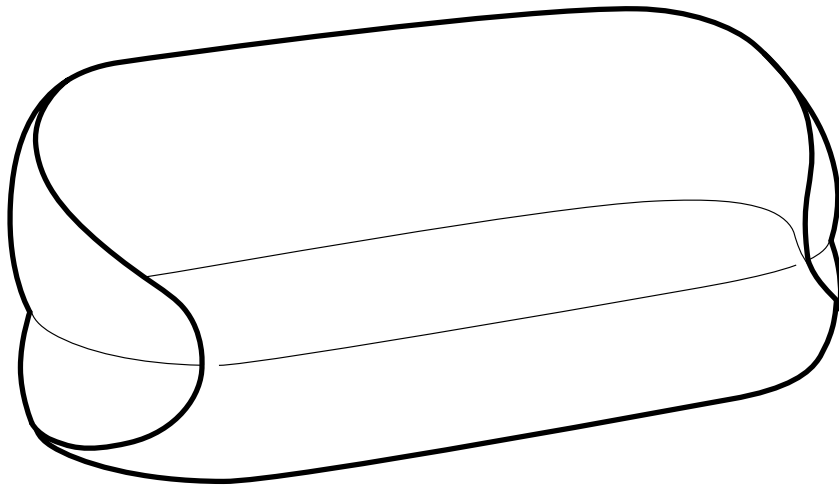

### 3-er sofa

- **Height:** 80cm
- **Width:** 221cm
- **Weight:** 70kg
- **Depth:** 93cm
- **Fabric:** 9,9mt
- **Volume:** 1,92 m<sup>3</sup>